

Jaw Couplings

MIKI PULLEY STARFLEX



High damping



High flexibility



High torque



Easy to mount and remove



Wide range of variations

Application	Machine tools, hydraulic equipment, pumps, fans, conveyors, textile machinery
Driver	Servo motor, stepper motor, induction motor

General-purpose Coupling of Simple Construction

Motive power is transmitted by a polyurethane elastomer that has the elasticity of rubber. As well as providing excellent absorption of vibrations and shock, these couplings transmit more than double the torque of older jaw couplings. The product range includes three types of hubs, two element hardnesses and two types of fit. This ensures the optimum combination for your transmission torque, response and misalignment. And the ability to combine different hubs means they can be used in a wide range of applications.



Various Types of Combinations

The line-up includes three types of hubs: pilot-bore products that allow free bore drilling, key/set screw types that enable high transmission torque, and clamp types that are easy to mount and remove.

No backlash

The R and Y types have no backlash and yet can absorb shock and vibration.

Reduced Counterforce

Optimal design of the element shape reduces mounting error counterforce to not damage the shaft.

Shaped like older models

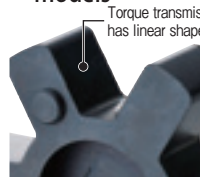

The shape of the torque transmission surface is linear.

ALS Y/R types

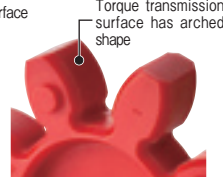

The shape of the torque transmission surface is arched. Combined with an undercut to reduce mounting error reaction force.

ALS B types

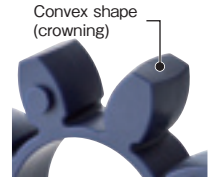

It is also made more flexible by its crowning shape and by removing material from the inner diameter.

COUPLINGS

ETP BUSHINGS

ELECTROMAGNETIC CLUTCHES & BRAKES

SPEED CHANGERS & REDUCERS

INVERTERS

LINEAR SHAFT DRIVES

TORQUE LIMITERS

ROSTA

SERIES

Metal Couplings	Metal Disc Couplings SERVOFLEX
	High-rigidity Couplings SERVORIGID
	Metal Slit Couplings HELI-CAL
	Metal Coil Spring Couplings BAUMANNFLEX
Rubber and Plastic Couplings	Pin Bushing Couplings PARAFLEX
	Link Couplings SCHMIDT
	Dual Rubber Couplings STEPFLEX
	Jaw Couplings MIKI PULLEY STARFLEX
	Jaw Couplings SPRFLEX
	Plastic Bellows Couplings BELLOWFLEX
	Rubber and Plastic Couplings CENTAFLEX

Available Models

There are three MIKI PULLEY STARFLEX models. Each has a different type of element.

ALS R

These are JIS A tight-fit, high-torque, high-response models that have a shore hardness of 97.



ALS Y

These are JIS A tight-fit models that have a shore hardness of 90 and are equipped with a good balance of torque transmission performance, flexibility, and responsiveness.



ALS B

These are JIS A loose-fit, high-torque, flexible models that have a shore hardness of 97.



Model Selection

Model/Type	Nominal torque [N·m]	Hub material	Shore hardness (Element) JIS A	Element fit	Transmission torque	Flexibility	No-backlash	Operating temperature [°C]
ALS R	0 ~ 525	Aluminum alloy	97	Tight fit (pre-compressed construction)	◎	○	○	-30 ~ 80
ALS Y	1.2 ~ 310	Aluminum alloy	90	Tight fit (pre-compressed construction)	○	○	○	-30 ~ 80
ALS B	12.5 ~ 525	Aluminum alloy	97	Loose fit	◎	◎	—	-30 ~ 80

Structure and Materials

Pilot Bore

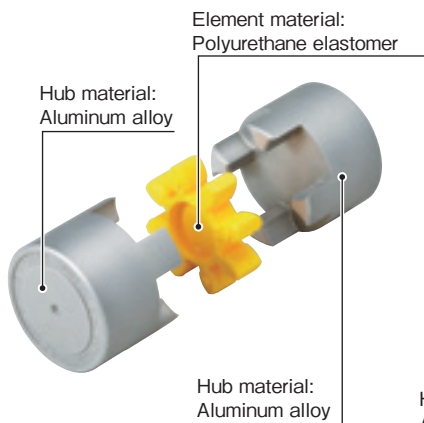

Key/Set Screw Type

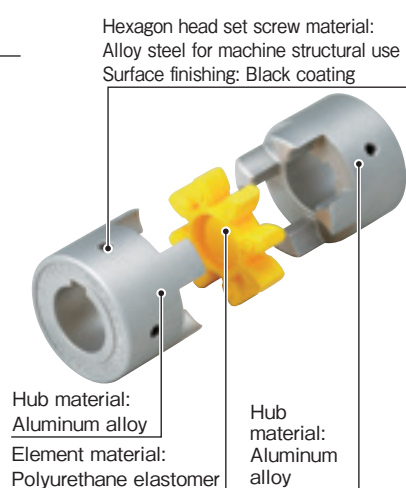

Clamp Type

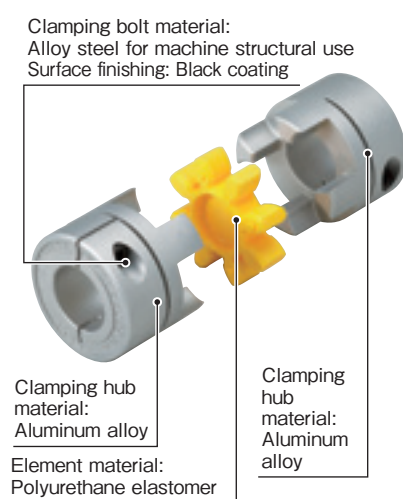

MODELS

ALS

Metal Couplings	Metal Disc Couplings SERVOFLEX
	High-rigidity Couplings SERVORIGID
	Metal Slit Couplings HELI-CAL
	Metal Coil Spring Couplings BAUMANNFLEX
	Pin Bushing Couplings PARAFLEX
	Link Couplings SCHMIDT
Rubber and Plastic Couplings	Dual Rubber Couplings STEPFLEX
	Jaw Couplings MIKI PULLEY STARFLEX
	Jaw Couplings SPRFLEX
	Plastic Bellows Couplings BELLOWFLEX
Rubber and Plastic Couplings CENTAFLEX	

FAQ

Q1 How long is the MIKI PULLEY STARFLEX service life?

A If power transmission is your primary goal, select an appropriate coupling using the selection procedures of the catalog, then you can expect long-term use. Service life will vary with usage environment and conditions and is heavily affected by usage temperature and mounting misalignment. Contact Miki Pulley for details.

Q2 Can they be used in excess of the nominal torque?

A They can, up to ten times daily when operating 8 hours per day, but not in excess of the maximum torque. This assumes startup torque of a motor with a low frequency of starting and stopping.

Q3 What exactly is a loose fit element?

A These elements have a convex (crowning) shape to the torque transmission surface. They greatly increase the permissible mounting misalignment. They are also easy to assemble, since they set a loose fit with the hub. This can reduce the number of work steps.

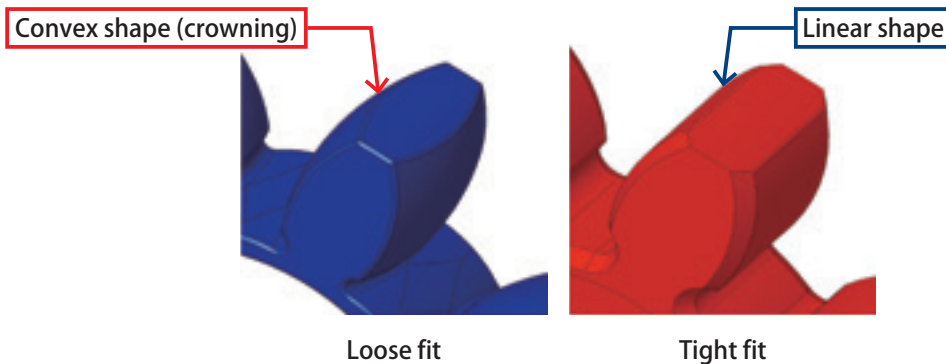

Q4 Does MIKI PULLEY STARFLEX develop no-backlash as it ages?

A MIKI PULLEY STARFLEX achieves no-backlash by preliminary compression of the element, so it may not be able to maintain no-backlash as the plastic ages. If you are considering using one in no-backlash mode over a long period of time, we recommend setting the service factor based on load property to a high value. If you require high precision control for a longer period, we recommend the SERVOFLEX series of metal disc couplings.

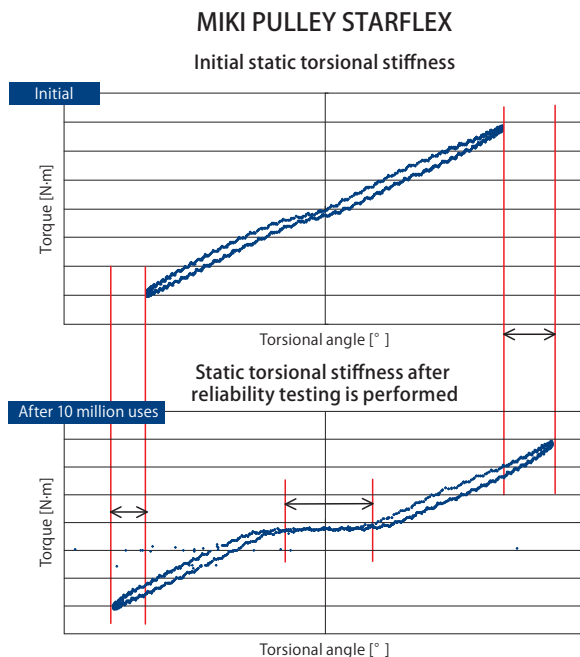
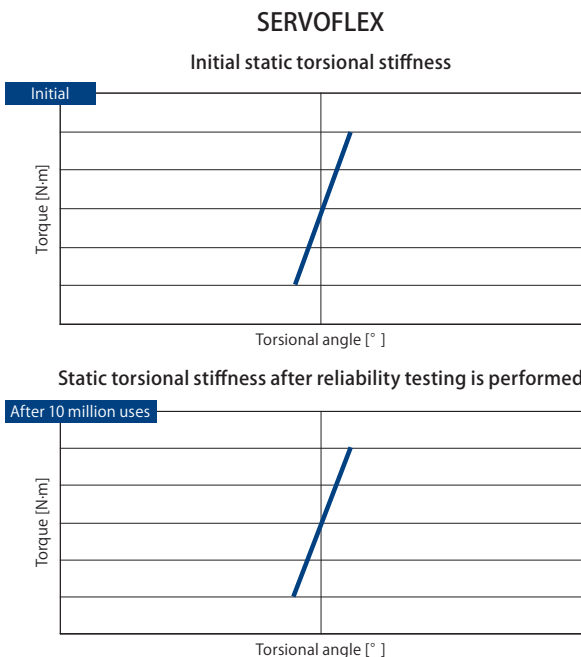

ALS R Types Key/Set Screw Type

Specifications

Model	Torque		Misalignment			Max. rotation speed [min ⁻¹]	Static torsional stiffness [N-m/rad]	Radial stiffness [N/mm]	Moment of inertia [kg-m ²]	Mass [kg]
	Nominal [N-m]	Max. [N-m]	Parallel [mm]	Angular [°]	Axial [mm]					
ALS-014-R	2	4	0.10	1	0 ~ +0.6	34100	21	380	1.91 × 10 ⁻⁷	0.007
ALS-020-R	5	10	0.10	1	0 ~ +0.8	23800	43	400	1.08 × 10 ⁻⁶	0.018
ALS-030-R	12.5	25	0.10	1	0 ~ +1.0	15900	136	650	6.25 × 10 ⁻⁶	0.047
ALS-040-R	17	34	0.10	1	0 ~ +1.2	11900	1550	1700	3.87 × 10 ⁻⁵	0.15
ALS-055-R	60	120	0.10	1	0 ~ +1.4	8700	2000	1350	1.66 × 10 ⁻⁴	0.35
ALS-065-R	160	320	0.10	1	0 ~ +1.5	7400	3100	1400	3.57 × 10 ⁻⁴	0.51
ALS-080-R	325	650	0.10	1	0 ~ +1.8	6000	6000	1710	1.06 × 10 ⁻³	1.01
ALS-095-R	450	900	0.10	1	-0.5 ~ +2.0	5000	10000	4200	2.24 × 10 ⁻³	1.50
ALS-105-R	525	1050	0.15	1	-0.9 ~ +2.0	4500	12000	5000	3.72 × 10 ⁻³	2.05

* Axial displacement of the ALS-014-R to ALS-080-R is not allowed in the negative direction.
 * Max. rotation speed does not take into account dynamic balance.
 * Stiffness values given are from measurements taken at 20°C
 * The moment of inertia and mass are measured for the maximum bore diameter.

Dimensions

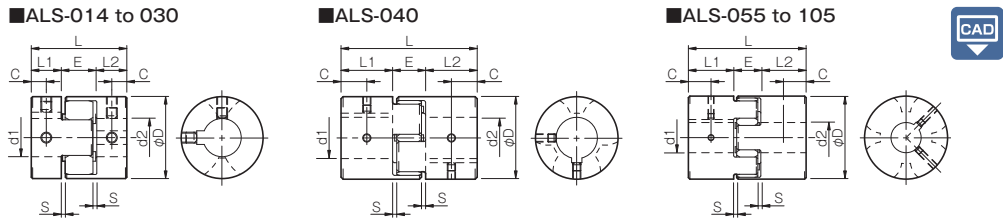

Model	d1 · d2			D	L	L1 · L2	E	S	C	Unit [mm]
	Pilot bore	Min.	Max.							
ALS-014-R	3	3	6.5	14	22	7	8	1	3.5	
ALS-020-R	4	4	9.6	20	30	10	10	1	5	
ALS-030-R	5	6	14	30	35	11	13	1.5	5.5	
ALS-040-R	5	8	22	40	66	25	16	2	12.5	
ALS-055-R	5	10	28	55	78	30	18	2	15	
ALS-065-R	5	14	38	65	90	35	20	2.5	17.5	
ALS-080-R	10	19	45	80	114	45	24	3	22.5	
ALS-095-R	8	19	55	95	126	50	26	3	25	
ALS-105-R	10	19	60	105	140	56	28	3.5	28	

* "Pilot bore" refers to center processing.

Standard Bore Diameter

Model	Standard bore diameter d1, d2 [mm]																																			
	3	4	5	6	6.35	7	8	9	9.525	10	11	12	14	15	16	17	18	19	20	22	24	25	28	30	32	35	38	40	42	45	48	50	55	56	60	
ALS-014-R	●	●	●	●	●																															
ALS-020-R		●	●	●	●	●	●	●	●	●																										
ALS-030-R				●	●	●	●	●	●	●	●	●	●																							
ALS-040-R							●	●	●	●	●	●	●	●	●	●	●	●	●	●	●	●	●	●	●	●	●	●	●	●	●	●	●	●	●	●
ALS-055-R											●	●	●	●	●	●	●	●	●	●	●	●	●	●	●	●	●	●	●	●	●	●	●	●	●	●
ALS-065-R														●	●	●	●	●	●	●	●	●	●	●	●	●	●	●	●	●	●	●	●	●	●	●
ALS-080-R																							●	●	●	●	●	●	●	●	●	●	●	●	●	●
ALS-095-R																							●	●	●	●	●	●	●	●	●	●	●	●	●	●
ALS-105-R																							●	●	●	●	●	●	●	●	●	●	●	●	●	●

* The bore diameters marked with ● are supported as standard bore diameter.
 * ø 11 and below have no keyway; ø12 and above can be processed for old JIS standards, new JIS standards, and new standard motors.

How to Place an Order

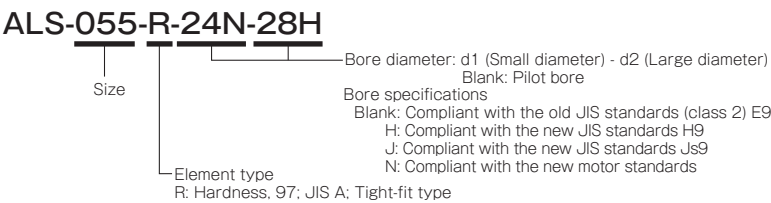

ALS R Types Clamp Type

COUPLINGS

ETP BUSHINGS

ELECTROMAGNETIC CLUTCHES & BRAKES

SPEED CHANGERS & REDUCERS

INVERTERS

LINEAR SHAFT DRIVES

TORQUE LIMITERS

ROSTA

SERIES

- Metal Disc Couplings
SERVOFLEX
- High-rigidity Couplings
SERVORIGID
- Metal Slit Couplings
HELI-CAL
- Metal Coil Spring Couplings
BAUMANNFLEX
- Pin Bushing Couplings
PARAFLEX
- Link Couplings
SCHMIDT
- Dual Rubber Couplings
STEPFLEX
- Rubber and Plastic Couplings
MIKI PULLEY STARFLEX
- Jaw Couplings
SPRFLEX
- Plastic Bellows Couplings
BELLOWFLEX
- Rubber and Plastic Couplings
CENTAFLEX

Specifications

Model	Misalignment			Max. rotation speed [min ⁻¹]	Static torsional stiffness [N-m/rad]	Radial stiffness [N/mm]	Moment of inertia [kg-m ²]	Mass [kg]
	Parallel [mm]	Angular [°]	Axial [mm]					
ALS-014-R	0.10	1	0 ~ +0.6	10000	21	380	1.98 × 10 ⁻⁷	0.007
ALS-020-R	0.10	1	0 ~ +0.8	10000	43	400	1.09 × 10 ⁻⁶	0.019
ALS-030-R	0.10	1	0 ~ +1.0	10000	136	650	6.19 × 10 ⁻⁶	0.045
ALS-040-R	0.10	1	0 ~ +1.2	10000	1550	1700	4.01 × 10 ⁻⁵	0.16
ALS-055-R	0.10	1	0 ~ +1.4	7000	2000	1350	1.63 × 10 ⁻⁴	0.34
ALS-065-R	0.10	1	0 ~ +1.5	5900	3100	1400	3.69 × 10 ⁻⁴	0.54
ALS-080-R	0.10	1	0 ~ +1.8	4800	6000	1710	1.04 × 10 ⁻³	1.00

* Axial displacement is not allowed in the negative direction.
 * Max. rotation speed does not take into account dynamic balance.
 * Stiffness values given are from measurements taken at 20°C
 * The moment of inertia and mass are measured for the maximum bore diameter.

Dimensions

■ALS-014 to 030

■ALS-040

■ALS-055 to 080

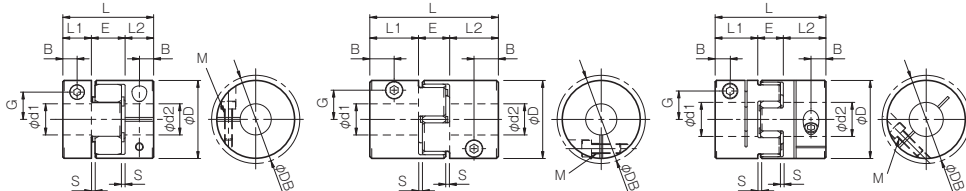

Model	d1 · d2		D	DB	L	L1 · L2	E	S	B	G	M	Tightening torque [N·m]
	Min.	Max.										
ALS-014-R	3	6	14	16.1	22	7	8	1	3.5	4.8	1-M2	0.4
ALS-020-R	4	8	20	20	30	10	10	1	5	6.5	1-M2.5	1
ALS-030-R	6	14	30	30	35	11	13	1.5	5.5	10.5	1-M3	1.5
ALS-040-R	8	20	40	43.2	66	25	16	2	12.5	15	1-M5	7
ALS-055-R	10	28	55	55	78	30	18	2	10.5	20	1-M6	14
ALS-065-R	14	35	65	69.8	90	35	20	2.5	11.5	24.5	1-M8	30
ALS-080-R	19	45	80	80	114	45	24	3	11.5	30	1-M8	30

* The øDB value is measured assuming that the head of the clamping bolt is larger than the external diameter of the hub.
 * The nominal diameter for the clamping bolt M is equal to the quantity minus the nominal diameter of the screw threads, where the quantity is for a hub on one side.

Standard Bore Diameter and Rated Transmission Torque

Model	Standard bore diameter d1, d2 [mm] and rated transmission torque [N·m]																														
	3	4	5	6	6.35	7	8	9	9.525	10	11	12	14	15	16	18	19	20	22	24	25	28	30	32	35	38	40	42	45		
ALS-014-R	0.31	0.42	0.54	0.65																											
ALS-020-R	1.2	1.6	2.1	2.2	2.6	3.0																									
ALS-030-R				2.0	2.2	2.7	3.4	4	4.4	4.7	5.4	6.0	7.4																		
ALS-040-R							8	12	14	16	19	23	31	34	34	34	34														
ALS-055-R											21	25	28	35	38	41	48	51	54	61	67	71	80								
ALS-065-R													40	44	47	54	58	61	68	75	79	89	96	103	114						
ALS-080-R															53	59	72	84	90	108	121	133	151	170	182	194	212				

* Bore diameters whose fields contain numbers are supported as the standard bore diameters.
 * Bore diameters whose fields contain numbers are restricted in their rated transmission torque by the holding power of the shaft connection component. The numbers indicate the rated transmission torque value [N·m].
 * The recommended processing tolerance for paired mounting shafts is the h7 class. However, for a shaft diameter of ø35, the tolerance is $^{+0.010}_{-0.025}$.
 * Bore diameters between the minimum and maximums shown in the dimensions table are compatible, but bore diameters other than those shown in the above table require other arrangements. Contact Miki Pulley for details.

MODELS

ALS

How to Place an Order

ALS-055-R-24B-28B

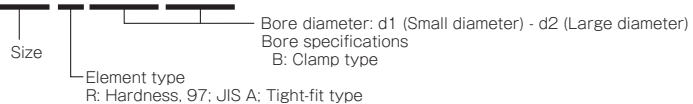

ALS Y Types Key/Set Screw Type

Specifications

Model	Torque		Misalignment			Max. rotation speed [min ⁻¹]	Static torsional stiffness [N-m/rad]	Radial stiffness [N/mm]	Moment of inertia [kg-m ²]	Mass [kg]
	Nominal [N-m]	Max. [N-m]	Parallel [mm]	Angular [°]	Axial [mm]					
ALS-014-Y	1.2	2.4	0.10	1	0 ~ +0.6	34100	12	200	1.91 × 10 ⁻⁷	0.007
ALS-020-Y	3	6	0.15	1	0 ~ +0.8	23800	24	210	1.08 × 10 ⁻⁶	0.018
ALS-030-Y	7.5	15	0.15	1	0 ~ +1.0	15900	73	330	6.25 × 10 ⁻⁶	0.047
ALS-040-Y	10	20	0.10	1	0 ~ +1.2	11900	760	940	3.87 × 10 ⁻⁵	0.15
ALS-055-Y	35	70	0.15	1	0 ~ +1.4	8700	1400	1160	1.66 × 10 ⁻⁴	0.35
ALS-065-Y	95	190	0.15	1	0 ~ +1.5	7400	2100	1200	3.57 × 10 ⁻⁴	0.51
ALS-080-Y	190	380	0.15	1	0 ~ +1.8	6000	4000	1430	1.06 × 10 ⁻³	1.01
ALS-095-Y	265	530	0.15	1	-0.5 ~ +2.0	5000	6000	2400	2.24 × 10 ⁻³	1.50
ALS-105-Y	310	620	0.20	1	-0.9 ~ +2.0	4500	7000	4000	3.72 × 10 ⁻³	2.05

* Axial displacement of the ALS-014-Y to ALS-080-Y is not allowed in the negative direction.
 * Max. rotation speed does not take into account dynamic balance.
 * Stiffness values given are from measurements taken at 20°C
 * The moment of inertia and mass are measured for the maximum bore diameter.

Dimensions

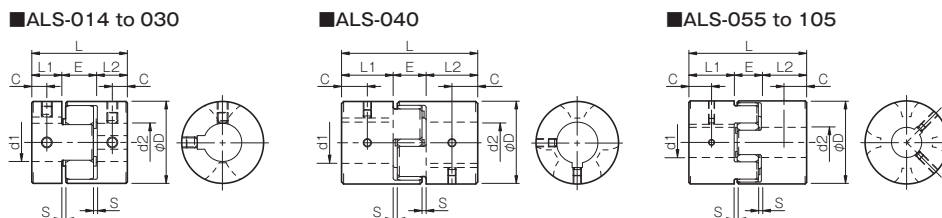

Model	d1 · d2			D	L	L1 · L2	E	S	C
	Pilot bore	Min.	Max.						
ALS-014-Y	3	3	6.5	14	22	7	8	1	3.5
ALS-020-Y	4	4	9.6	20	30	10	10	1	5
ALS-030-Y	5	6	14	30	35	11	13	1.5	5.5
ALS-040-Y	5	8	22	40	66	25	16	2	12.5
ALS-055-Y	5	10	28	55	78	30	18	2	15
ALS-065-Y	5	14	38	65	90	35	20	2.5	17.5
ALS-080-Y	10	19	45	80	114	45	24	3	22.5
ALS-095-Y	8	19	55	95	126	50	26	3	25
ALS-105-Y	10	19	60	105	140	56	28	3.5	28

* "Pilot bore" refers to center processing.

Standard Bore Diameter

Model	Standard bore diameter d1, d2 [mm]																																			
	3	4	5	6	6.35	7	8	9	9.525	10	11	12	14	15	16	17	18	19	20	22	24	25	28	30	32	35	38	40	42	45	48	50	55	56	60	
ALS-014-Y	●	●	●	●	●																															
ALS-020-Y		●	●	●	●	●	●	●	●	●																										
ALS-030-Y				●	●	●	●	●	●	●	●	●	●	●	●	●	●	●	●	●	●	●	●	●	●	●	●	●	●	●	●	●	●	●	●	
ALS-040-Y							●	●	●	●	●	●	●	●	●	●	●	●	●	●	●	●	●	●	●	●	●	●	●	●	●	●	●	●	●	●
ALS-055-Y										●	●	●	●	●	●	●	●	●	●	●	●	●	●	●	●	●	●	●	●	●	●	●	●	●	●	●
ALS-065-Y												●	●	●	●	●	●	●	●	●	●	●	●	●	●	●	●	●	●	●	●	●	●	●	●	●
ALS-080-Y																																				
ALS-095-Y																																				
ALS-105-Y																																				

* The bore diameters marked with ● are supported as standard bore diameter.
 * ●11 and below have no keyway; ●12 and above can be processed for old JIS standards, new JIS standards, and new standard motors.

How to Place an Order

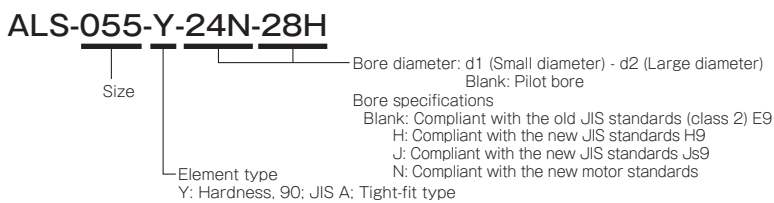

ALS Y Types Clamp Type

COUPLINGS

ETP BUSHINGS

ELECTROMAGNETIC CLUTCHES & BRAKES

SPEED CHANGERS & REDUCERS

INVERTERS

LINEAR SHAFT DRIVES

TORQUE LIMITERS

ROSTA

SERIES

- Metal Disc Couplings
SERVOFLEX
- High-rigidity Couplings
SERVORIGID
- Metal Slit Couplings
HELI-CAL
- Metal Coil Spring Couplings
BAUMANNFLEX
- Pin Bushing Couplings
PARAFLEX
- Link Couplings
SCHMIDT
- Dual Rubber Couplings
STEPFLEX
- Jaw Couplings**
MIKI PULLEY
STARFLEX
- Jaw Couplings
SPRFLEX
- Plastic Bellows Couplings
BELLOWFLEX
- Rubber and Plastic Couplings
CENTAFLEX

MODELS

ALS

Specifications

Model	Misalignment			Max. rotation speed [min ⁻¹]	Static torsional stiffness [N-m/rad]	Radial stiffness [N/mm]	Moment of inertia [kg-m ²]	Mass [kg]
	Parallel [mm]	Angular [°]	Axial [mm]					
ALS-014-Y	0.10	1	0 ~ +0.6	10000	12	200	1.98 × 10 ⁻⁷	0.007
ALS-020-Y	0.15	1	0 ~ +0.8	10000	24	210	1.09 × 10 ⁻⁶	0.019
ALS-030-Y	0.15	1	0 ~ +1.0	10000	73	330	6.19 × 10 ⁻⁶	0.045
ALS-040-Y	0.10	1	0 ~ +1.2	10000	760	940	4.01 × 10 ⁻⁵	0.16
ALS-055-Y	0.15	1	0 ~ +1.4	7000	1400	1160	1.63 × 10 ⁻⁴	0.34
ALS-065-Y	0.15	1	0 ~ +1.5	5900	2100	1200	3.69 × 10 ⁻⁴	0.54
ALS-080-Y	0.15	1	0 ~ +1.8	4800	4000	1430	1.04 × 10 ⁻³	1.00

* Axial displacement is not allowed in the negative direction.
 * Max. rotation speed does not take into account dynamic balance.
 * Stiffness values given are from measurements taken at 20°C
 * The moment of inertia and mass are measured for the maximum bore diameter.

Dimensions

■ALS-014 to 030

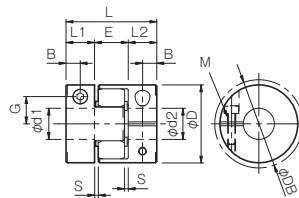

■ALS-040

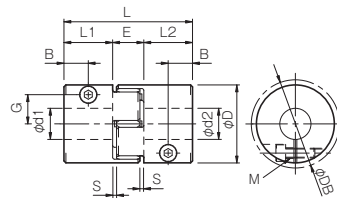

■ALS-055 to 080

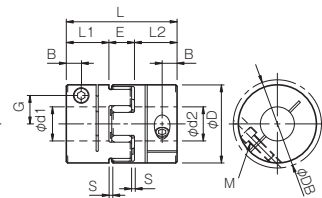

Unit [mm]

Model	d1 · d2		D	DB	L	L1 · L2	E	S	B	G	M	Tightening torque [N·m]
	Min.	Max.										
ALS-014-Y	3	6	14	16.1	22	7	8	1	3.5	4.8	1-M2	0.4
ALS-020-Y	4	8	20	20	30	10	10	1	5	6.5	1-M2.5	1
ALS-030-Y	6	14	30	30	35	11	13	1.5	5.5	10.5	1-M3	1.5
ALS-040-Y	8	20	40	43.2	66	25	16	2	12.5	15	1-M5	7
ALS-055-Y	10	28	55	55	78	30	18	2	10.5	20	1-M6	14
ALS-065-Y	14	35	65	69.8	90	35	20	2.5	11.5	24.5	1-M8	30
ALS-080-Y	19	45	80	80	114	45	24	3	11.5	30	1-M8	30

* The øDB value is measured assuming that the head of the clamping bolt is larger than the external diameter of the hub.
 * The nominal diameter for the clamping bolt M is equal to the quantity minus the nominal diameter of the screw threads, where the quantity is for a hub on one side.

Standard Bore Diameter and Rated Transmission Torque

型式	標準穴径 d1 · d2 [mm] と許容伝達トルク [N · m]																													
	3	4	5	6	6.35	7	8	9	9.525	10	11	12	14	15	16	18	19	20	22	24	25	28	30	32	35	38	40	42	45	
ALS-014-Y	0.31	0.42	0.54	0.65																										
ALS-020-Y		1.2	1.6	2.1	2.2	2.6	3.0																							
ALS-030-Y				2.0	2.2	2.7	3.4	4	4.4	4.7	5.4	6.0	7.4																	
ALS-040-Y								8	12	14	16	19	20	20	20	20	20	20	20											
ALS-055-Y														21	25	28	35	38	41	48	51	54	61	67	70	70				
ALS-065-Y																														
ALS-080-Y																														

* Bore diameters whose fields contain numbers are supported as the standard bore diameters.
 * Bore diameters whose fields contain numbers are restricted in their rated transmission torque by the holding power of the shaft connection component. The numbers indicate the rated transmission torque value [N·m].
 * The recommended processing tolerance for paired mounting shafts is the h7 class. However, for a shaft diameter of ø35, the tolerance is ± 0.010 .
 * Bore diameters between the minimum and maximums shown in the dimensions table are compatible, but bore diameters other than those shown in the above table require other arrangements. Contact Miki Pulley for details.

How to Place an Order

ALS-055-Y-24B-28B

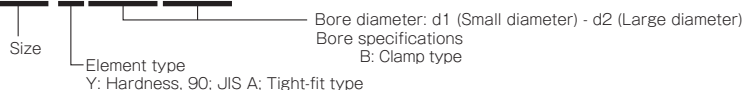

ALS B Types Key/Set Screw Type

Specifications

Model	Torque		Misalignment			Max. rotation speed [min ⁻¹]	Static torsional stiffness [N-m/rad]	Radial stiffness [N/mm]	Moment of inertia [kg-m ²]	Mass [kg]
	Nominal [N-m]	Max. [N-m]	Parallel [mm]	Angular [°]	Axial [mm]					
ALS-030-B	12.5	25	0.17	1	-0.2 ~ +1.0	15900	90	460	6.13×10^{-6}	0.045
ALS-040-B	17	34	0.20	1	-0.5 ~ +1.2	11900	400	640	3.86×10^{-5}	0.15
ALS-055-B	60	120	0.22	1	-0.2 ~ +1.4	8700	1150	400	1.66×10^{-4}	0.35
ALS-065-B	160	320	0.25	1	-0.6 ~ +1.5	7400	2000	800	3.57×10^{-4}	0.51
ALS-080-B	325	650	0.28	1	-0.9 ~ +1.8	6000	4550	600	1.06×10^{-3}	1.01
ALS-095-B	450	900	0.32	1	-0.5 ~ +2.0	5000	12000	800	2.22×10^{-3}	1.48
ALS-105-B	525	1050	0.36	1	-0.9 ~ +2.0	4500	15000	2000	3.70×10^{-3}	2.02

* Max. rotation speed does not take into account dynamic balance.
 * Stiffness values given are from measurements taken at 20°C
 * The moment of inertia and mass are measured for the maximum bore diameter.

Dimensions

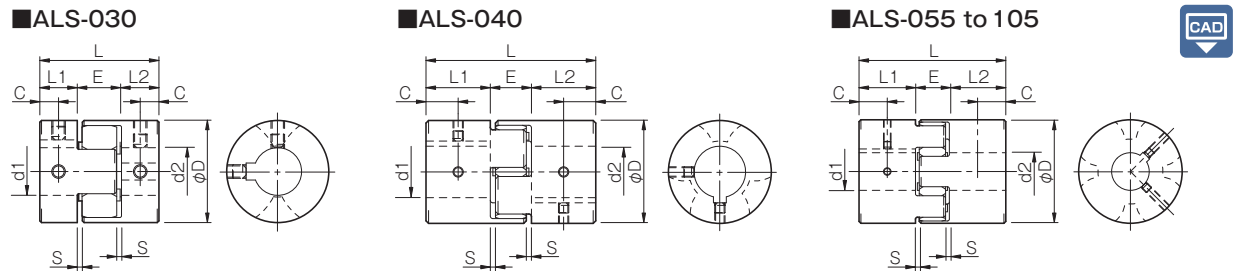

Model	d1 · d2			D	L	L1 · L2	E	S	C	Unit [mm]
	Pilot bore	Min.	Max.							
ALS-030-B	5	6	14	30	35	11	13	1.5	5.5	
ALS-040-B	5	8	22	40	66	25	16	2	12.5	
ALS-055-B	5	10	28	55	78	30	18	2	15	
ALS-065-B	5	14	38	65	90	35	20	2.5	17.5	
ALS-080-B	10	19	45	80	114	45	24	3	22.5	
ALS-095-B	8	19	55	95	126	50	26	3	25	
ALS-105-B	10	19	60	105	140	56	28	3.5	28	

* "Pilot bore" refers to center processing.

Standard Bore Diameter

Model	Standard bore diameter d1, d2 [mm]																																
	6	6.35	7	8	9	9.525	10	11	12	14	15	16	17	18	19	20	22	24	25	28	30	32	35	38	40	42	45	48	50	55	56	60	
ALS-030-B	●	●	●	●	●	●	●	●	●	●																							
ALS-040-B				●	●	●	●	●	●	●	●	●	●	●	●	●	●	●	●	●	●	●	●	●	●	●	●	●	●	●	●	●	●
ALS-055-B							●	●	●	●	●	●	●	●	●	●	●	●	●	●	●	●	●	●	●	●	●	●	●	●	●	●	●
ALS-065-B										●	●	●	●	●	●	●	●	●	●	●	●	●	●	●	●	●	●	●	●	●	●	●	●
ALS-080-B															●	●	●	●	●	●	●	●	●	●	●	●	●	●	●	●	●	●	●
ALS-095-B															●	●	●	●	●	●	●	●	●	●	●	●	●	●	●	●	●	●	●
ALS-105-B															●	●	●	●	●	●	●	●	●	●	●	●	●	●	●	●	●	●	●

* The bore diameters marked with ● are supported as standard bore diameter.
 * ø 11 and below have no keyway; ø 12 and above can be processed for old JIS standards, new JIS standards, and new standard motors.

How to Place an Order

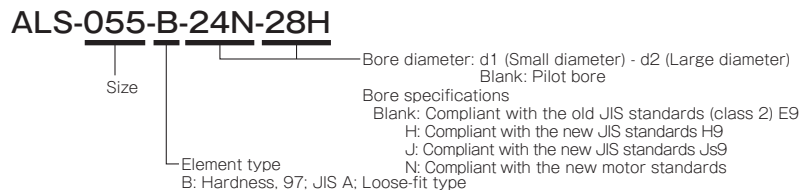

ALS B Types Clamp Type

COUPLINGS

ETP BUSHINGS

ELECTROMAGNETIC CLUTCHES & BRAKES

SPEED CHANGERS & REDUCERS

INVERTERS

LINEAR SHAFT DRIVES

TORQUE LIMITERS

ROSTA

SERIES

- Metal Disc Couplings
SERVOFLEX
- High-rigidity Couplings
SERVORIGID
- Metal Slit Couplings
HELI-CAL
- Metal Coil Spring Couplings
BAUMANNFLEX
- Pin Bushing Couplings
PARAFLEX
- Link Couplings
SCHMIDT
- Dual Rubber Couplings
STEPFLEX
- Rubber and Plastic Couplings
MIKI PULLEY STARFLEX
- Rubber and Plastic Couplings
SPRFLEX
- Plastic Bellows Couplings
BELLOWFLEX
- Rubber and Plastic Couplings
CENTAFLEX

Specifications

Model	Misalignment			Max. rotation speed [min ⁻¹]	Static torsional stiffness [N-m/rad]	Radial stiffness [N/mm]	Moment of inertia [kg-m ²]	Mass [kg]
	Parallel [mm]	Angular [°]	Axial [mm]					
ALS-030-B	0.17	1	-0.2 ~ +1.0	10000	90	460	6.07 × 10 ⁻⁶	0.043
ALS-040-B	0.20	1	-0.5 ~ +1.2	10000	400	640	4.00 × 10 ⁻⁵	0.16
ALS-055-B	0.22	1	-0.2 ~ +1.4	7000	1150	400	1.63 × 10 ⁻⁴	0.34
ALS-065-B	0.25	1	-0.6 ~ +1.5	5900	2000	800	3.69 × 10 ⁻⁴	0.54
ALS-080-B	0.28	1	-0.9 ~ +1.8	4800	4550	600	1.04 × 10 ⁻³	1.00

* Max. rotation speed does not take into account dynamic balance.
 * Stiffness values given are from measurements taken at 20°C
 * The moment of inertia and mass are measured for the maximum bore diameter.

Dimensions

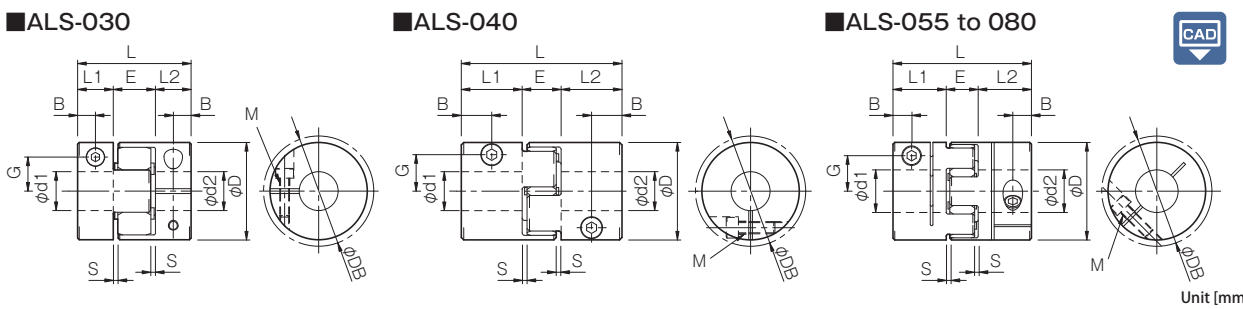

Model	d1 · d2		D	DB	L	L1 · L2	E	S	B	G	M	Tightening torque [N-m]
	Min.	Max.										
ALS-030-B	6	14	30	30	35	11	13	1.5	5.5	10.5	1-M3	1.5
ALS-040-B	8	20	40	43.2	66	25	16	2	12.5	15	1-M5	7
ALS-055-B	10	28	55	55	78	30	18	2	10.5	20	1-M6	14
ALS-065-B	14	35	65	69.8	90	35	20	2.5	11.5	24.5	1-M8	30
ALS-080-B	19	45	80	80	114	45	24	3	11.5	30	1-M8	30

* The ØDB value is measured assuming that the head of the clamping bolt is larger than the external diameter of the hub.
 * The nominal diameter for the clamping bolt M is equal to the quantity minus the nominal diameter of the screw threads, where the quantity is for a hub on one side.

Standard Bore Diameter and Rated Transmission Torque

Model	Standard bore diameter d1, d2 [mm] and rated transmission torque [N-m]																									
	6	6.35	7	8	9	9.525	10	11	12	14	15	16	18	19	20	22	24	25	28	30	32	35	38	40	42	45
ALS-030-B	2.0	2.2	2.7	3.4	4	4.4	4.7	5.4	6.0	7.4																
ALS-040-B				8	12	14	16	19	23	31	34	34	34	34												
ALS-055-B							21	25	28	35	38	41	48	51	54	61	67	71	80							
ALS-065-B											40	44	47	54	58	61	68	75	79	89	96	103	114			
ALS-080-B														53	59	72	84	90	108	121	133	151	170	182	194	212

* Bore diameters whose fields contain numbers are supported as the standard bore diameters.
 * Bore diameters whose fields contain numbers are restricted in their rated transmission torque by the holding power of the shaft connection component. The numbers indicate the rated transmission torque value [N-m].
 * The recommended processing tolerance for paired mounting shafts is the h7 class. However, for a shaft diameter of ø35, the tolerance is $^{+0.010}_{-0.025}$.
 * Bore diameters between the minimum and maximums shown in the dimensions table are compatible, but bore diameters other than those shown in the above table require other arrangements. Contact Miki Pulley for details.

How to Place an Order

ALS-055-B-24B-28B

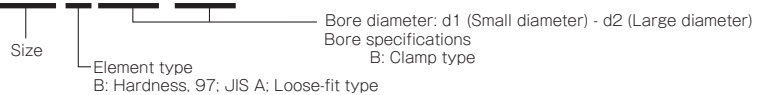

ALS Elements

Dimensions

ALS R/Y

■ ALS-014 to 030-R·Y

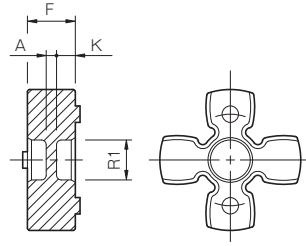

■ ALS-040-R·Y

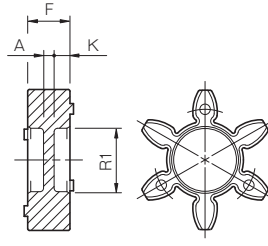

■ ALS-055 to 065-R·Y

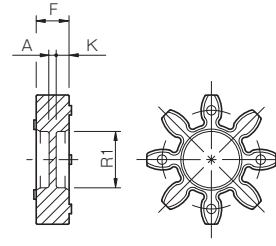

■ ALS-080 to 105-R·Y

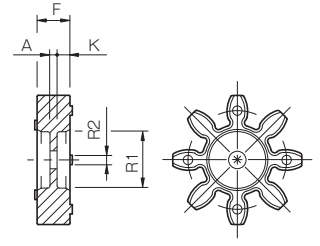

Unit [mm]

Model	F	R1	R2	K	A
ALS-014-□-EL	6.2	3.5	—	2.5	1.2
ALS-020-□-EL	8.2	6.2	—	3.4	1.4
ALS-030-□-EL	10.2	8.5	—	4	2.2
ALS-040-□-EL	12	18	—	4.5	3
ALS-055-□-EL	14	24	—	5.5	3
ALS-065-□-EL	15	30	—	5.5	4
ALS-080-□-EL	18	37	15	7	4
ALS-095-□-EL	20	43	20	8	4
ALS-105-□-EL	21	50	20	8.5	4

How to Place an Order

ALS-055-R-EL

Size | Element only
 Element type
 R: Hardness, 97; JIS A; Tight-fit type
 Y: Hardness, 90; JIS A; Tight-fit type

ALS B

■ ALS-030-B

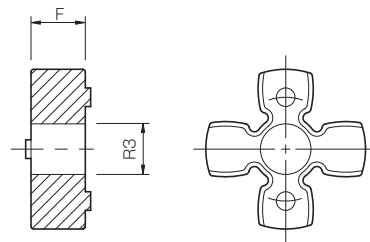

■ ALS-040-B

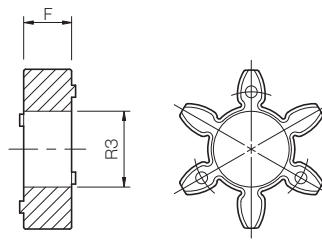

■ ALS-055 to 105-B

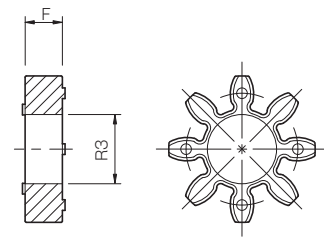

Unit [mm]

Model	F	R3
ALS-030-B-EL	10.2	10.5
ALS-040-B-EL	12	18.5
ALS-055-B-EL	14	27.5
ALS-065-B-EL	15	32
ALS-080-B-EL	18	41
ALS-095-B-EL	20	47
ALS-105-B-EL	21	50

How to Place an Order

ALS-055-B-EL

Size | Element only
 Element type
 B: Hardness, 97; JIS A; Loose-fit type

COUPLINGS

ETP BUSHINGS

ELECTROMAGNETIC CLUTCHES & BRAKES

SPEED CHANGERS & REDUCERS

INVERTERS

LINEAR SHAFT DRIVES

TORQUE LIMITERS

ROSTA

Standard Hole-Drilling Standards

- Set screw and keyway positions are not on the same plane. Positioning precision for keyway milling is determined by sight, so contact Miki Pulley when the keyway requires a positioning precision for a particular hub.
- The set screws are included with the product.
- We also process non-standard bore diameters to the standards of the table below.
- Contact Miki Pulley if you require standards other than those shown below.

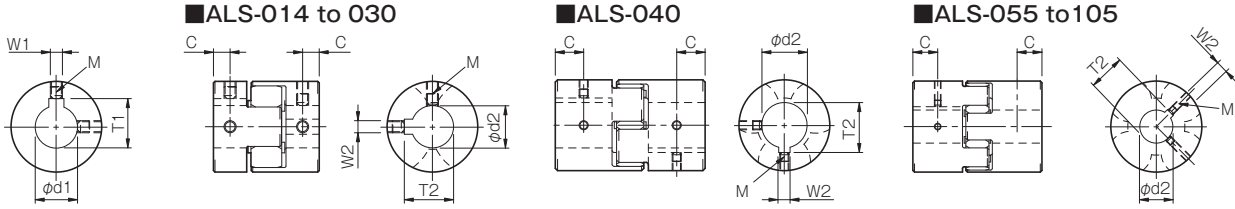

Unit [mm]

Models compliant with the old JIS standards (class 2)					Models compliant with the new JIS standards (H9)					Models compliant with the new JIS standards (Js9)				Models compliant with the new motor standards						
Nominal bore diameter	Bore diameter [d1 · d2]	Keyway width [W1 · W2]	Keyway height [T1 · T2]	Set screw hole [M]	Nominal bore diameter	Bore diameter [d1 · d2]	Keyway width [W1 · W2]	Keyway height [T1 · T2]	Set screw hole [M]	Nominal bore diameter	Bore diameter [d1 · d2]	Keyway width [W1 · W2]	Keyway height [T1 · T2]	Set screw hole [M]	Nominal bore diameter	Bore diameter [d1 · d2]	Keyway width [W1 · W2]	Keyway height [T1 · T2]	Set screw hole [M]	
Tolerance	H7,H8	E9	+0.3 0	—	Tolerance	H7	H9	+0.3 0	—	Tolerance	H7, H8	Js9	+0.3 0	—	Tolerance	G7,F7	H9	+0.3 0	—	
3	3 +0.018 0	—	—	1-M3	—	—	—	—	—	—	—	—	—	—	—	—	—	—	—	—
4	4 +0.018 0	—	—	2-M3	—	—	—	—	—	—	—	—	—	—	—	—	—	—	—	—
5	5 +0.018 0	—	—	2-M3	—	—	—	—	—	—	—	—	—	—	—	—	—	—	—	—
6	6 +0.018 0	—	—	2-M4	—	—	—	—	—	—	—	—	—	—	—	—	—	—	—	—
6.35	6.35 +0.022 0	—	—	2-M4	—	—	—	—	—	—	—	—	—	—	—	—	—	—	—	—
7	7 +0.022 0	—	—	2-M4	—	—	—	—	—	—	—	—	—	—	—	—	—	—	—	—
8	8 +0.022 0	—	—	2-M4	—	—	—	—	—	—	—	—	—	—	—	—	—	—	—	—
9	9 +0.022 0	—	—	2-M4	—	—	—	—	—	—	—	—	—	—	—	—	—	—	—	—
9.525	9.525 +0.022 0	—	—	2-M4	—	—	—	—	—	—	—	—	—	—	—	—	—	—	—	—
10	10 +0.022 0	—	—	2-M4	—	—	—	—	—	—	—	—	—	—	—	—	—	—	—	—
11	11 +0.018 0	—	—	2-M4	—	—	—	—	—	—	—	—	—	—	—	—	—	—	—	—
12	12 +0.018 0	4 +0.050 +0.020	13.5	2-M4	12H	12 +0.018 0	4 +0.030 0	13.8	2-M4	12J	12 +0.018 0	4 ±0.0150	13.8	2-M4	—	—	—	—	—	—
14	14 +0.018 0	5 +0.050 +0.020	16.0	2-M4	14H	14 +0.018 0	5 +0.030 0	16.3	2-M4	14J	14 +0.018 0	5 ±0.0150	16.3	2-M4	14N	14 +0.024 +0.006	5 +0.030 0	16.3	2-M4	—
15	15 +0.018 0	5 +0.050 +0.020	17.0	2-M4	15H	15 +0.018 0	5 +0.030 0	17.3	2-M4	15J	15 +0.018 0	5 ±0.0150	17.3	2-M4	—	—	—	—	—	—
16	16 +0.018 0	5 +0.050 +0.020	18.0	2-M4	16H	16 +0.018 0	5 +0.030 0	18.3	2-M4	16J	16 +0.018 0	5 ±0.0150	18.3	2-M4	—	—	—	—	—	—
17	17 +0.018 0	5 +0.050 +0.020	19.0	2-M4	17H	17 +0.018 0	5 +0.030 0	19.3	2-M4	17J	17 +0.018 0	5 ±0.0150	19.3	2-M4	—	—	—	—	—	—
18	18 +0.018 0	5 +0.050 +0.020	20.0	2-M4	18H	18 +0.018 0	6 +0.030 0	20.8	2-M5	18J	18 +0.018 0	6 ±0.0150	20.8	2-M5	—	—	—	—	—	—
19	19 +0.021 0	5 +0.050 +0.020	21.0	2-M4	19H	19 +0.021 0	6 +0.030 0	21.8	2-M5	19J	19 +0.021 0	6 ±0.0150	21.8	2-M5	19N	19 +0.028 +0.007	6 +0.030 0	21.8	2-M5	—
20	20 +0.021 0	5 +0.050 +0.020	22.0	2-M4	20H	20 +0.021 0	6 +0.030 0	22.8	2-M5	20J	20 +0.021 0	6 ±0.0150	22.8	2-M5	—	—	—	—	—	—
22	22 +0.021 0	7 +0.061 +0.025	25.0	2-M6	22H	22 +0.021 0	6 +0.030 0	24.8	2-M5	22J	22 +0.021 0	6 ±0.0150	24.8	2-M5	—	—	—	—	—	—
24	24 +0.021 0	7 +0.061 +0.025	27.0	2-M6	24H	24 +0.021 0	8 +0.036 0	27.3	2-M6	24J	24 +0.021 0	8 ±0.0180	27.3	2-M6	24N	24 +0.028 +0.007	8 +0.036 0	27.3	2-M6	—
25	25 +0.021 0	7 +0.061 +0.025	28.0	2-M6	25H	25 +0.021 0	8 +0.036 0	28.3	2-M6	25J	25 +0.021 0	8 ±0.0180	28.3	2-M6	—	—	—	—	—	—
28	28 +0.021 0	7 +0.061 +0.025	31.0	2-M6	28H	28 +0.021 0	8 +0.036 0	31.3	2-M6	28J	28 +0.021 0	8 ±0.0180	31.3	2-M6	28N	28 +0.028 +0.007	8 +0.036 0	31.3	2-M6	—
30	30 +0.021 0	7 +0.061 +0.025	33.0	2-M6	30H	30 +0.021 0	8 +0.036 0	33.3	2-M6	30J	30 +0.021 0	8 ±0.0180	33.3	2-M6	—	—	—	—	—	—
32	32 +0.025 0	10 +0.061 +0.025	35.5	2-M8	32H	32 +0.025 0	10 +0.036 0	35.3	2-M8	32J	32 +0.025 0	10 ±0.0180	35.3	2-M8	—	—	—	—	—	—
35	35 +0.025 0	10 +0.061 +0.025	38.5	2-M8	35H	35 +0.025 0	10 +0.036 0	38.3	2-M8	35J	35 +0.025 0	10 ±0.0180	38.3	2-M8	—	—	—	—	—	—
38	38 +0.025 0	10 +0.061 +0.025	41.5	2-M8	38H	38 +0.025 0	10 +0.036 0	41.3	2-M8	38J	38 +0.025 0	10 ±0.0180	41.3	2-M8	38N	38 +0.050 +0.025	10 +0.036 0	41.3	2-M8	—
40	40 +0.025 0	10 +0.061 +0.025	43.5	2-M8	40H	40 +0.025 0	12 +0.043 0	43.3	2-M8	40J	40 +0.025 0	12 ±0.0215	43.3	2-M8	—	—	—	—	—	—
42	42 +0.025 0	12 +0.075 +0.032	45.5	2-M8	42H	42 +0.025 0	12 +0.043 0	45.3	2-M8	42J	42 +0.025 0	12 ±0.0215	45.3	2-M8	42N	42 +0.050 +0.025	12 +0.043 0	45.3	2-M8	—
45	45 +0.025 0	12 +0.075 +0.032	48.5	2-M8	45H	45 +0.025 0	14 +0.043 0	48.8	2-M10	45J	45 +0.025 0	14 ±0.0215	48.8	2-M10	—	—	—	—	—	—
48	48 +0.025 0	12 +0.075 +0.032	51.5	2-M8	48H	48 +0.025 0	14 +0.043 0	51.8	2-M10	48J	48 +0.025 0	14 ±0.0215	51.8	2-M10	48N	48 +0.050 +0.025	14 +0.043 0	51.8	2-M10	—
50	50 +0.025 0	12 +0.075 +0.032	53.5	2-M8	50H	50 +0.025 0	14 +0.043 0	53.8	2-M10	50J	50 +0.025 0	14 ±0.0215	53.8	2-M10	—	—	—	—	—	—
55	55 +0.030 0	15 +0.075 +0.032	60.0	2-M10	55H	55 +0.030 0	16 +0.043 0	59.3	2-M10	55J	55 +0.030 0	16 ±0.0215	59.3	2-M10	55N	55 +0.060 +0.030	16 +0.043 0	59.3	2-M10	—
56	56 +0.030 0	15 +0.075 +0.032	61.0	2-M10	56H	56 +0.030 0	16 +0.043 0	60.3	2-M10	56J	56 +0.030 0	16 ±0.0215	60.3	2-M10	—	—	—	—	—	—
60	60 +0.030 0	15 +0.075 +0.032	65.0	2-M10	60H	60 +0.030 0	18 +0.043 0	64.4	2-M10	60J	60 +0.030 0	18 ±0.0215	64.4	2-M10	60N	60 +0.060 +0.030	18 +0.043 0	64.4	2-M10	—

* Tolerance will be h8 class for hole diameter equal to or less than φ10 mm.
* The set screw size is M3 for ALS-014.

Distance from Set Screw Edge

Model	ALS-014	ALS-020	ALS-030	ALS-040	ALS-055	ALS-065	ALS-080	ALS-095	ALS-105
Distance from set screw edge C [mm]	3.5	5	5.5	12.5	15	17.5	22.5	25	28

SERIES

- Metal Disc Couplings SERVOFLEX
- High-rigidity Couplings SERVORIGID
- Metal Slit Couplings HELI-CAL
- Metal Coil Spring Couplings BAUMANNFLEX
- Pin Bushing Couplings PARAFLEX
- Link Couplings SCHMIDT
- Dual Rubber Couplings STEPFLEX
- Jaw Couplings MIKI PULLEY STARFLEX
- Jaw Couplings SPRFLEX
- Plastic Bellows Couplings BELLOWFLEX
- Rubber and Plastic Couplings CENTAFLEX

MODELS

ALS

ALS Models

Items Checked for Design Purposes

Special Items to Take Note of

You should note the following to prevent any problems.

- (1) Always be careful of parallel, angular, and axial misalignment.
- (2) Always tighten bolts with the specified torque.

Precautions for Handling

ALS models come with three different types of elements and two different types of mounting hubs. Be aware in their handling that their allowable values and points of caution are not the same.

- (1) Couplings are designed for use within an operating temperature range of -30°C to 80°C .
- (2) Although elements are designed to be oilproof, do not subject them to excessive amounts of oil as it may cause deterioration. Use and storage in direct sunlight may shorten element service life, so cover elements appropriately.
- (3) Do not tighten up clamping bolts on clamp-type ALS models until after inserting the mounting shaft.

Mounting

- (1) Remove any rust, dust, oil residue, etc. from the inner diameter surfaces of the shaft and couplings. In particular, never allow oil or grease containing antifriction or other agent (molybdenum-, silicon-, or fluorine-based), which would dramatically affect the friction coefficient, to contact the surface.

- (2) Insert and mount the shaft far enough so that the paired mounting shafts touch the entire length of the clamping hub of the coupling (dimensions chart L1, L2), and does not interfere with the elements or the other shaft.

After mounting the left and right hubs, check also that the total coupling length (L in the dimensions chart) does not exceed the permitted axial tolerance. If the total coupling length cannot be checked, use a feeler gauge or similar tool to check that the gap between the left and right hubs (S in the dimensions chart) does not exceed the permitted axial tolerance.

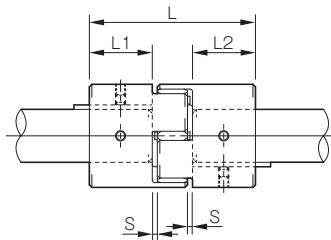

Model	L [mm]	L1 · L2 [mm]	S [mm]
ALS-014	22	7	1
ALS-020	30	10	1
ALS-030	35	11	1.5
ALS-040	66	25	2
ALS-055	78	30	2
ALS-065	90	35	2.5
ALS-080	114	45	3
ALS-095	126	50	3
ALS-105	140	56	3.5

- (3) To get full coupling performance, mount couplings so that differences between coupling centers during operation are within the misalignment shown in the specifications table. However, this misalignment is the maximum value when each occurs independently, so make the allowable value when they combine 50% or less of this value.

- (4) Check centering by holding a straight-edge to the outer circumference of the main body, using two points about 90° apart. The centering precision has a major impact on the service life of the element. We recommend aligning the centering locations as the method for centering the two shafts.

Misalignment

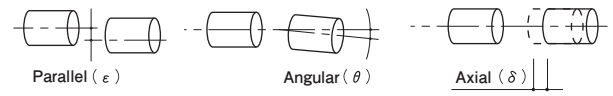

Model	Parallel ε [mm]	Angular θ [°]	Axial δ [mm]	Axial total length L [mm]
ALS-014-R	0.10	1	0 ~ +0.6	22 ~ 22.6
ALS-020-R	0.10	1	0 ~ +0.8	30 ~ 30.8
ALS-030-R	0.10	1	0 ~ +1.0	35 ~ 36.0
ALS-040-R	0.10	1	0 ~ +1.2	66 ~ 67.2
ALS-055-R	0.10	1	0 ~ +1.4	78 ~ 79.4
ALS-065-R	0.10	1	0 ~ +1.5	90 ~ 91.5
ALS-080-R	0.10	1	0 ~ +1.8	114 ~ 115.8
ALS-095-R	0.10	1	-0.5 ~ +2.0	125.5 ~ 128.0
ALS-105-R	0.15	1	-0.9 ~ +2.0	139.1 ~ 142.0

Model	Parallel ε [mm]	Angular θ [°]	Axial δ [mm]	Axial total length L [mm]
ALS-014-Y	0.10	1	0 ~ +0.6	22 ~ 22.6
ALS-020-Y	0.15	1	0 ~ +0.8	30 ~ 30.8
ALS-030-Y	0.15	1	0 ~ +1.0	35 ~ 36.0
ALS-040-Y	0.10	1	0 ~ +1.2	66 ~ 67.2
ALS-055-Y	0.15	1	0 ~ +1.4	78 ~ 79.4
ALS-065-Y	0.15	1	0 ~ +1.5	90 ~ 91.5
ALS-080-Y	0.15	1	0 ~ +1.8	114 ~ 115.8
ALS-095-Y	0.15	1	-0.5 ~ +2.0	125.5 ~ 128.0
ALS-105-Y	0.20	1	-0.9 ~ +2.0	139.1 ~ 142.0

Model	Parallel ε [mm]	Angular θ [°]	Axial δ [mm]	Axial total length L [mm]
ALS-030-B	0.17	1	-0.2 ~ +1.0	34.8 ~ 36.0
ALS-040-B	0.20	1	-0.5 ~ +1.2	65.5 ~ 67.2
ALS-055-B	0.22	1	-0.2 ~ +1.4	77.8 ~ 79.4
ALS-065-B	0.25	1	-0.6 ~ +1.5	89.4 ~ 91.5
ALS-080-B	0.28	1	-0.9 ~ +1.8	113.1 ~ 115.8
ALS-095-B	0.32	1	-0.5 ~ +2.0	125.5 ~ 128.0
ALS-105-B	0.36	1	-0.9 ~ +2.0	139.1 ~ 142.0

- (5) Tighten set screws with hex socket heads and clamping bolts to the tightening torques shown below using a calibrated torque screwdriver or torque wrench.

Size of hex-socket-head set screw	M3	M4	M5	M6	M8	M10
Tightening torque [N·m]	0.7	1.7	3.6	6.0	14.5	28.0

Clamping bolt size	M2	M2.5	M3	M5	M6	M8
Tightening torque [N·m]	0.4	1.0	1.5	7.0	14.0	30.0

- (6) Do not use any hex-socket-head set screw or clamping bolt other than those specified by Miki Pulley. Do not apply oil, grease, or screw fixatives.

Selection Order of Nominal Bore Diameters when Ordering

When specifying bore diameters for key/set screw systems, you should basically specify d1 (small diameter)-d2 (large diameter). However, where d1=d2 (same diameters), please order using the selection order below.

Selection order	1	2	3	4
Nominal bore diameter	Blank	H	J	N
Standards	Old JIS/no keyway	New JIS H9	New JIS Js9	New motor standards

Key/set screw type hubs and clamp type hubs can be used in combination. When specifying bore diameters in this instance, specify d1: clamp type, d2: key/set screw type in that order, regardless of larger and smaller bore diameters.

Example) ALS-055-R-28B-19H



Selection Procedures

ALS models can be selected in one of two ways depending on their mode of use: ordinary use or no-backlash use (exploiting their pre-compressed construction). When considering use of couplings in no-backlash mode, however, be sure that use will be at a torque that is low enough for the nominal torque of the coupling. Note that selection criteria are different for ordinary use and use in no-backlash mode. When considering use of couplings in no-backlash mode, select from among the ALS-R and ALS-Y types. ALS-B types cannot be used in no-backlash mode.

Ordinary use

- Find the torque, T_a , applied to the coupling using the output capacity, P , of the driver and the usage rotation speed, n .

$$T_a \text{ [N}\cdot\text{m]} = 9550 \times \frac{P \text{ [kW]}}{n \text{ [min}^{-1}\text{]}}$$

- Determine the service factor K from the usage and operating conditions, and find the corrected torque, T_d , applied to the coupling.

$$T_d \text{ [N}\cdot\text{m]} = T_a \times K_1 \times K_2 \times K_3 \times K_4$$

Service factor based on load property: K1

Load properties	Constant	Vibrations: Small	Vibrations: Medium	Vibrations: Large
K1	1.0	1.25	1.75	2.25

Service factor based on operating time: K2

Hrs./day	~ 8	~ 16	~ 24
K2	1.0	1.12	1.25

Service factor based on starting/braking frequency: K3

Times/hr.	~ 10	~ 30	~ 60	~ 120	~ 240	Over 240
K3	1.0	1.1	1.3	1.5	2.0	2.5 ≤

Service factor based on operating temperature: K4

Temperature [°C]	- 30 ~ 30	30 ~ 40	40 ~ 60	60 ~ 80
K4	1.0	1.2	1.4	1.8

- Set the size so that the nominal torque of the coupling T_n is at least equal to the corrected torque, T_d .

$$T_n \geq T_d$$

- Select a size that results in a maximum torque, T_m , for the coupling that is at least equal to the peak torque, T_s , generated by the driver, follower or both. Maximum torque refers to the maximum amount of torque that can be applied for a set amount of time considering eight hours of operation per day and up to around ten instances.

$$T_m \geq T_s \times K_4$$

- When the required shaft diameter exceeds the maximum bore diameter of the selected size, select a suitable coupling.

- When the coupling is used in machinery prone to periodic violent load-torque fluctuations, torsional vibration must also be considered in addition to the above selection criteria. In other words, check that the vibration frequency of the torque fluctuation does not match the natural frequency of the shafting. The natural frequency is generally calculated by finding the natural frequency, f_e , of one section, approximating the shafting as shown in the diagram below.

$$f_e = \frac{1}{2\pi} \sqrt{\kappa \left(\frac{1}{J_A} + \frac{1}{J_B} \right)} \text{ [Hz]}$$

κ : Static torsional stiffness of coupling [N·m/rad]

J_A : Moment of inertia of driving side [kg·m²]

J_B : Moment of inertia of driven side [kg·m²]

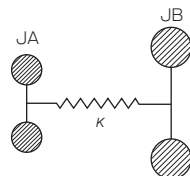

No-backlash use

- Find the torque, T_a , applied to the coupling using the output capacity, P , of the driver and the usage rotation speed, n .

$$T_a \text{ [N}\cdot\text{m]} = 9550 \times \frac{P \text{ [kW]}}{n \text{ [min}^{-1}\text{]}}$$

- Determine the service factor K from the usage and operating conditions, and find the corrected torque, T_d , applied to the coupling.

$$T_d \text{ [N}\cdot\text{m]} = T_a \times K_1 \times K_2 \times K_3 \times K_4$$

Service factor based on load property: K1

Load properties	Constant	Vibrations: Small	Vibrations: Medium	Vibrations: Large
K1	1.0	1.25	1.75	2.25

* When using in no-backlash mode, be sure that $K_1 \geq 4$.

Service factor based on operating time: K2

Hrs./day	~ 8	~ 16	~ 24
K2	1.0	1.12	1.25

Service factor based on starting/braking frequency: K3

Times/hr.	~ 10	~ 30	~ 60	~ 120	~ 240	Over 240
K3	1.0	1.1	1.3	1.5	2.0	2.5 ≤

Service factor based on operating temperature: K4

Temperature [°C]	- 30 ~ 30	30 ~ 40	40 ~ 60	60 ~ 80
K4	1.0	1.2	1.4	1.8

- Select a size that results in a peak torque T_s generated by the driver, follower or both that is no greater than the nominal torque T_n for the coupling.

$$T_n \geq T_s \times K_4$$

- When the required shaft diameter exceeds the maximum bore diameter of the selected size, select a suitable coupling. When using a clamping hub, the bore diameter may restrict the transmission torque. For that reason, check that the clamping-hub shaft holding force of the selected coupling size is at least equal to the peak torque, T_s , applied to the coupling.

Couplings can structurally be used in no-backlash mode while the element is pre-compressed, but backlash may start to occur with use. If you are considering using the coupling in no-backlash mode over a long period of time, we recommend setting the service factor K_1 to a high value. If you require higher precision control/positioning for a long period of time, we recommend our SERVOFLEX series of metal disc couplings.

COUPLINGS

ETP BUSHINGS

ELECTROMAGNETIC CLUTCHES & BRAKES

SPEED CHANGERS & REDUCERS

INVERTERS

LINEAR SHAFT DRIVES

TORQUE LIMITERS

ROSTA

SERIES

Metal Disc Couplings
SERVOFLEX

High-rigidity Couplings
SERVORIGID

Metal Slit Couplings
HELI-CAL

Metal Coil Spring Couplings
BAUMANNFLEX

Pin Bushing Couplings
PARAFLEX

Link Couplings
SCHMIDT

Dual Rubber Couplings
STEPFLEX

Jaw Couplings
MIKI PULLEY STARFLEX

Jaw Couplings
SPRFLEX

Plastic Bellows Couplings
BELLOWFLEX

Rubber and Plastic Couplings
CENTAFLEX

MODELS

ALS

ALS Models

Items Checked for Design Purposes

Induction Motor Specifications and Easy Selection Table

Motor		50 Hz: 3000 min ⁻¹ , 60 Hz: 3600 min ⁻¹				50 Hz: 1500min ⁻¹ , 60 Hz: 1800min ⁻¹				50 Hz: 1000min ⁻¹ , 60 Hz: 1200min ⁻¹			
		Two-pole motor		MIKI PULLEY STARFLEX		Four-pole motor		MIKI PULLEY STARFLEX		Six-pole motor		MIKI PULLEY STARFLEX	
Output [kW]	Frequency [Hz]	Shaft diameter [mm]	Torque [N·m]	Model	Nominal bore diameter	Shaft diameter [mm]	Torque [N·m]	Model	Nominal bore diameter	Shaft diameter [mm]	Torque [N·m]	Model	Nominal bore diameter
0.1	50	—	—	—	—	11	0.7	ALS-030	11	—	—	—	—
	60	—	—	—	—	11	0.5	ALS-030	11	—	—	—	—
0.2	50	11	0.7	ALS-030	11	11	1.3	ALS-030	11	—	—	—	—
	60	11	0.5	ALS-030	11	11	1.1	ALS-030	11	—	—	—	—
0.4	50	14	1.3	ALS-030	14N	14	2.6	ALS-030	14N	19	3.9	ALS-040	19N
	60	14	1.1	ALS-030	14N	14	2.2	ALS-030	14N	19	3.2	ALS-040	19N
0.75	50	19	2.4	ALS-040	19N	19	4.9	ALS-040	19N	24	7.3	ALS-055	24N
	60	19	2	ALS-040	19N	19	4.1	ALS-040	19N	24	6.1	ALS-055	24N
1.5	50	24	4.9	ALS-055	24N	24	9.7	ALS-055	24N	28	15	ALS-055	28N
	60	24	4.1	ALS-055	24N	24	8.1	ALS-055	24N	28	12	ALS-055	28N
2.2	50	24	7.1	ALS-055	24N	28	14	ALS-055	28N	28	21	ALS-065	28N
	60	24	6	ALS-055	24N	28	12	ALS-055	28N	28	18	ALS-065	28N
3.7	50	28	12	ALS-055	28N	28	24	ALS-065	28N	38	36	ALS-065	38N
	60	28	10	ALS-055	28N	28	20	ALS-065	28N	38	30	ALS-065	38N
5.5	50	38	18	ALS-065	38N	38	36	ALS-065	38N	38	54	ALS-080	38N
	60	38	15	ALS-065	38N	38	30	ALS-065	38N	38	45	ALS-065	38N
7.5	50	38	24	ALS-065	38N	38	49	ALS-065	38N	42	72	ALS-080	42N
	60	38	20	ALS-065	38N	38	41	ALS-065	38N	42	60	ALS-080	42N
11	50	42	36	ALS-080	42N	42	71	ALS-080	42N	42	108	ALS-080-R	42N
	60	42	30	ALS-080	42N	42	59	ALS-080	42N	42	90	ALS-080	42N
15	50	42	49	ALS-080	42N	42	97	ALS-080	42N	48	149	ALS-095-R	48N
	60	42	41	ALS-080	42N	42	81	ALS-080	42N	48	124	ALS-095	48N
18.5	50	42	65	ALS-080	42N	48	120	ALS-095	48N	55	183	ALS-095-R	55N
	60	42	50	ALS-080	42N	48	100	ALS-095	48N	55	152	ALS-095-R	55N
22	50	48	71	ALS-095	48N	48	143	ALS-095-R	48N	55	218	ALS-095-R	55N
	60	48	59	ALS-095	48N	48	119	ALS-095	48N	55	182	ALS-095-R	55N
30	50	55	97	ALS-095	55N	55	195	ALS-095-R	55N	60	296	—	60N
	60	55	81	ALS-095	55N	55	162	ALS-095-R	55N	60	247	ALS-105-R	60N
37	50	55	120	ALS-095	55N	60	240	ALS-105-R	60N	—	—	—	—
	60	55	100	ALS-095	55N	60	200	ALS-105-R	60N	—	—	—	—
45	50	55	146	ALS-105	55N	60	292	—	60N	—	—	—	—
	60	55	122	ALS-095	55N	60	243	ALS-105-R	60N	—	—	—	—

* The above table shows appropriate sizes for key types in ordinary use in an induction motor driver. It is not for making selections for use with no-backlash specifications.

* Motor rotation speed and output torque are calculated (reference) values.

Servo Motor Specifications and Easy Selection Table

Servo motor specifications					Corresponding coupling specifications	
Rated output [kW]	Rated rotation speed [min ⁻¹]	Rated torque [N·m]	Max. torque [N·m]	Shaft diameter [mm]	Model ALS-□-R	Max. bore diameter [mm]
0.05	3000	0.16	0.48	8	ALS-020-R	8
0.1	3000	0.32	0.95	8	ALS-020-R	8
0.2	3000	0.64	1.9	14	ALS-030-R	14
0.4	3000	1.30	3.8	14	ALS-030-R	14
0.5	2000	2.39	7.16	24	ALS-055-R	28
0.5	3000	1.59	4.77	24	ALS-055-R	28
0.75	2000	3.58	10.7	22	ALS-055-R	28
0.75	3000	2.40	7.2	19	ALS-040-R	20
0.85	1000	8.12	24.4	24	ALS-055-R	28
1	2000	4.78	14.4	24	ALS-055-R	28
1	3000	3.18	9.55	24	ALS-055-R	28
1.2	1000	11.50	34.4	35	ALS-065-R	35
1.5	2000	7.16	21.6	28	ALS-055-R	28
1.5	3000	4.78	14.3	24	ALS-055-R	28
2	2000	9.55	28.5	35	ALS-065-R	35
2	3000	6.37	15.9	24	ALS-055-R	28
3	1000	28.60	85.9	35	ALS-065-R	35
3.5	2000	16.70	50.1	35	ALS-065-R	35
3.5	3000	11.10	27.9	28	ALS-055-R	28
5	2000	23.90	71.6	35	ALS-065-R	35
5	3000	15.90	39.7	28	ALS-055-R	28
7	2000	33.40	100	35	ALS-065-R	35

* The above table was set up in simple terms for clamp types based on the shaft diameters of compatible servo motors and the rated transmission torque of the coupling. It is not guaranteed when using the couplings in the no-backlash mode.

COUPLINGS

ETP BUSHINGS

ELECTROMAGNETIC CLUTCHES & BRAKES

SPEED CHANGERS & REDUCERS

INVERTERS

LINEAR SHAFT DRIVES

TORQUE LIMITERS

ROSTA

SERIES

Metal Couplings	Metal Disc Couplings SERVOFLEX
	High-rigidity Couplings SERVORIGID
	Metal Slit Couplings HELI-CAL
	Metal Coil Spring Couplings BAUMANNFLEX
	Pin Bushing Couplings PARAFLEX
	Link Couplings SCHMIDT
	Dual Rubber Couplings STEPFLEX
	Jaw Couplings MIKI PULLEY STARFLEX
	Jaw Couplings SPRFLEX
	Plastic Bellows Couplings BELLOWFLEX
Rubber and Plastic Couplings	Rubber and Plastic Couplings CENTAFLEX

MODELS

ALS